

SKIPPER

CU-M001

PanelPC 9inch touch display

User Manual

Preliminary

SKIPPER DL2 Dual Axis Doppler Speed Log System

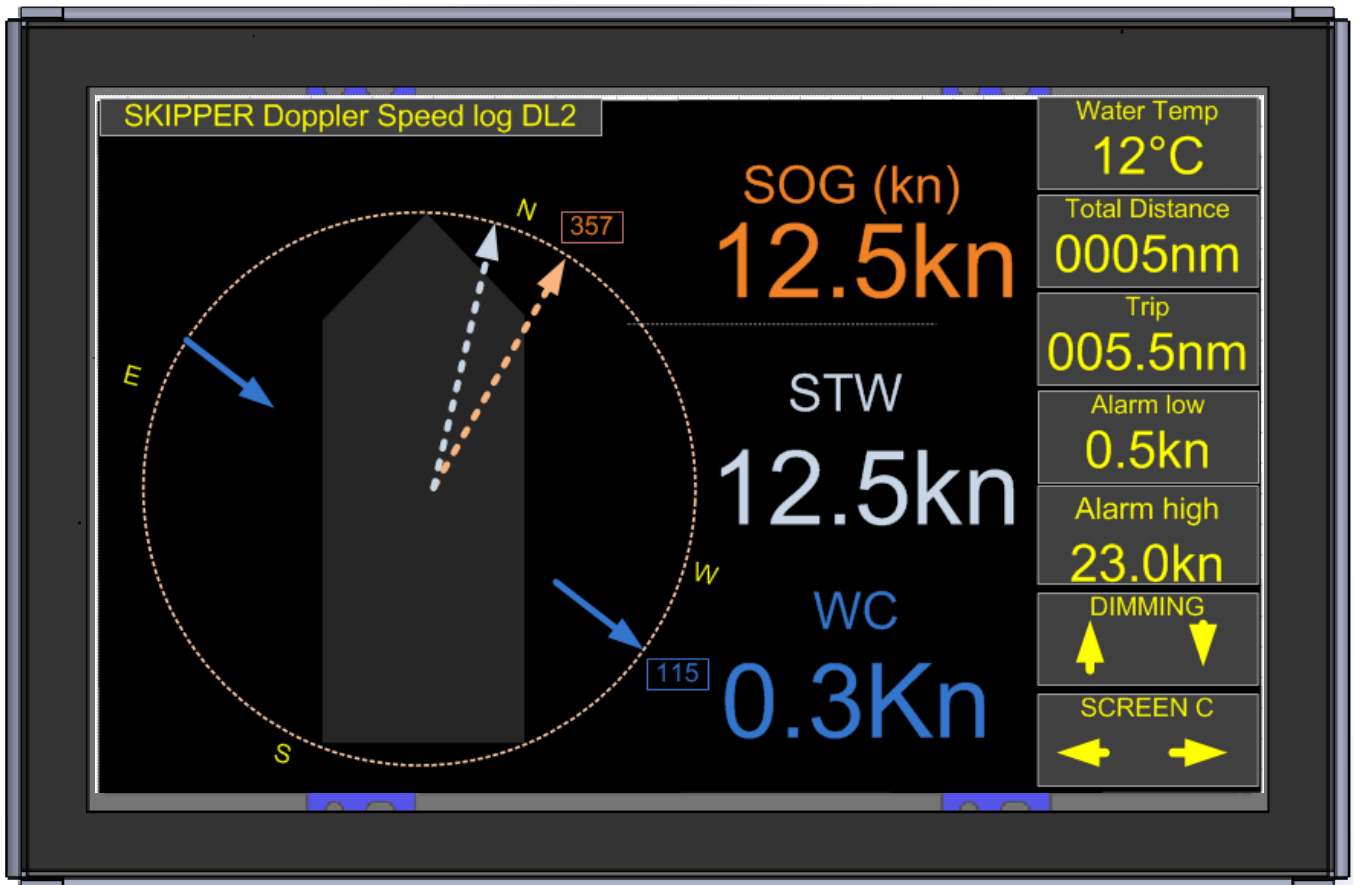

SKIPPER Electronics AS
Enebakkveien 150
P. O. Box 151, Manglerud
0612 Oslo, Norway
www.skipper.no

Telephone: +47 23 30 22 70
Telefax: +47 23 30 22 71
E-mail: support@skipper.no
Co. reg. no: NO-965378847-MVA

Document no: DM-M003-SA
Rev: 1430
For software ver: 1.0.0
Edition: 2014-09-23

Preliminary

Weitergabe sowie vervielfältigung dieser unterlage, verwertung und mitteilung ihres Inhaltes nicht gestattet, soweit nicht ausdrücklich zugestanden. Zuwiderhandlungen verpflichten zu schadenersatz.

Toute communication ou reproduction de ce document, toute Exploitation ou communication de ou son contenu sont interdites, sauf autorisation expresse. Tout manquement à cette règle est illicite et expose son auteur au versement de dommages et intérêts.

Copying of this document, and giving it to others and the use or communication of contents thereof, are forbidden without express authority. Offenders are liable to the payment of damages.

Sin nuestra expresa autorización, queda terminantemente prohibida la reproducción total o parcial de este documento, así como su uso indebido y/o su exhibición o comunicación a terceros. De los infractores se exigirá el correspondiente resarcimiento de daños y perjuicios.

COMMUNICATING WITH US

If you need more information, support or other assistance from us, do not hesitate to contact us:

SKIPPER Electronics AS
P. O. Box 151, Manglerud
NO-0612 Oslo
Norway

Phone: (+47) 23 30 22 70, Fax: (+47) 23 30 22 71
E-mail: support@skipper.no

SOFTWARE UPDATES AND TECHNICAL SUPPORT

Find us on the internet: www.skipper.no

YOUR FEEDBACK IS APPRECIATED

If you find errors, misspellings or poorly explained sections in this document, please do not hesitate to contact us at:

support@skipper.no

CONTENTS

TERMINOLOGY.....	5
Terms used in this manual.....	5
Units	5
Abbreviations.....	5
CHAPTER 1: INTRODUCTION	6
Introduction.....	6
DL2 Introduction	7
Alarms	7
Distance	8
The control unit.....	8
Maintenance.....	8
Diagnostics.....	8
CHAPTER 2: DL2 SCREENS.....	9
Run time screens	9
Setup	16
Calibration	16
Step 1. Heading error correction:	17
Step 2a. Manual speed calibration/adjustment:	18
Step 2b. Semi automatic calibration:	18
Calibration routine:	18
Custom transducer	20
Calibrating the secondary sensors	20
Depth.....	20
Improving performance	20
CHAPTER 3: NORMAL USAGE.....	21
Changing screens and dimming.....	21
Runtime screen 1	21
Speed display.....	22
Depth display.....	22
Loss of bottom track/open ocean	22
Display of bottom track from GPS	22
Surface current measurement.....	22
Other parameters	22
Setting the alarms	22
Tracking mode.....	22
Trip	23
Runtime screen 2	23
CHAPTER 4: WHEN SOMETHING IS WRONG.....	24
Setting up communications	25
CHAPTER 5: SYSTEM DOCUMENTATION.....	26
NOTES	27

TERMINOLOGY

TERMS USED IN THIS MANUAL

UNITS

Unless otherwise stated, all values shown on the display are as follows:

Speed	Kn
Distance	Meters
Depth	Meters
Power	% of max output

ABBREVIATIONS

In addition, the following symbols are used

WT	Water track
BT	Bottom track
STW	Speed through water
SOG	Speed over ground
Trip	Text for trip/total
ECDIS	Electronic Chart Display and Information System
INS	Inertial Navigation System
VDR	Voyage Data Recorder

CHAPTER 1: INTRODUCTION

INTRODUCTION

The CU-M001 is a 9" touch display used for operation control of SKIPPER DL2 Dual axis Doppler speed log.

The CU-M001 is designed to be flush mounted, wall mounted or desk mounted.

Preliminary

DL2 INTRODUCTION

The dual axis Doppler speed log system (DL2) works by the Doppler principle. This principle is that a sound bouncing off a moving object will change in frequency. This principle can be utilized by making a narrow beam of sound and analyzing the frequency of the returning sound. This frequency change is proportional to the relative speed of the sound projector and reflecting object.

On a vessel, a transducer is positioned pointing slightly in one direction and the reflected sound comes from particles in the water or the bottom. The frequency of these echoes is translated to speed. By having more transducers pointing in various directions, the speed can be measured in two axis.

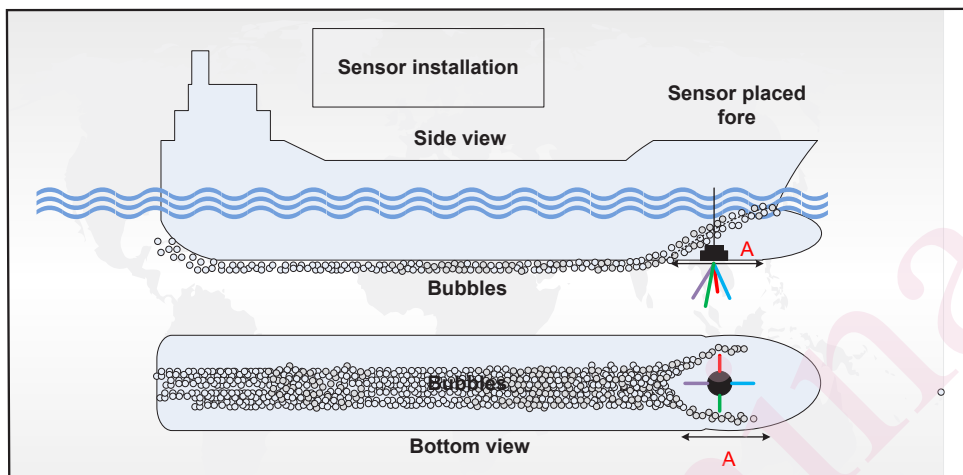

The DL2 system has sound beams in directions angled out from the vertical to get good speed definition, but also to measure bottom speed at as great a depth as possible. These are angled so that two axis (longitudinal and transversal) can be detected. It sends from all beams at the same time but at slightly different frequencies so that the beams do not mix. The transducers are moulded into the same sensor head together with the amplifiers and detection circuitry (transceiver).

The sensor also contains temperature sensors and tilt sensors to allow compensation of the data. The transceiver contains a small computer which processes the data and signals and converts them to speeds. This data is sent to the electronic unit (JB70D2-XX) where it is formatted and presented on screen and web page, and as data in formats to be integrated into the vessels navigation and presentation systems such as repeaters and conning.

SPEED

The screen presents speed through water (STW) used for the autopilot, radar and logged on the voyage data recorder (VDR). The speed data is also used for setting limits on the rudder and stabilizer wings. It also shows speed over ground (SOG) used as a primary system for speed, however this information is also available from the GPS systems. By adding an approved gyro heading input into the system, together with parameters of the vessel, it is possible for the system to calculate the transversal speed at any point of the vessel. This feature known as docking, allows the pilot to be sure that both the fore and aft of the vessel are under tight control.

ALARMS

Alarms can be set on the speed, usually speed through water, and these are commonly used to warn the crew if the vessel is in danger of losing rudder steerage, or if the vessel is going over its

recommended speeds.

DISTANCE

In addition the system shows distance travelled through water and has a resettable daily trip counter. This information is used for service intervals and navigation. Extra information is available regarding the sea temperature and tilt of the vessel.

THE CONTROL UNIT

The user can operate the system via a simple to use touch screen or using a web page on the conning unit. The displays are intuitive and have a menu system, but also allows the user to click on the screen to adjust the relevant parameters. Full setup, calibration and diagnostics are available from the screens. Calibration is performed by a simple two leg sailing procedure, and once set, should not need repeating unless the sensor is moved.

MAINTENANCE

The system is low maintenance. After initial setup and calibration, the system requires no attention except to change alarm parameters if required. The sensor is exposed to the water and over time some growth may appear. This can be carefully removed when possible, and is normally not a problem except if the vessel is still for longer periods of time (weeks) in warm waters. The effect of this growth is usually seen as the range of the bottom track being reduced.

DIAGNOSTICS

The system has comprehensive built in test (BIT) that can be used to analyse the performance of the equipment and give a warning if the data is not within specification. It also has inbuilt redundancy in some areas, such that even if a failure occurs, it can still give some data. Due to the systems LAN network point, it is possible to set up the system for remote diagnostics and upgrade using network. In time this will help reduce service visits and increase the probability of first time fix.

CHAPTER 2: DL2 SCREENS

RUN TIME SCREENS

The DL2 display has 5 main runtime displays A-E. and a fifth “Screen menu” to enter sub screens..



Screen A
Basic



Screen B
Combination
(Programable)
(Optional)



Screen C
Docking
(Option)

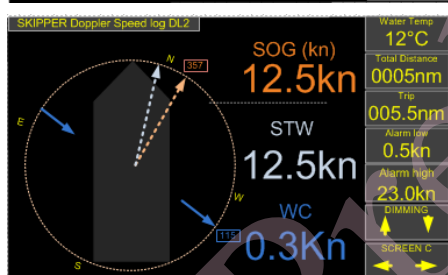

Screen D
Rose diagram
(Option)

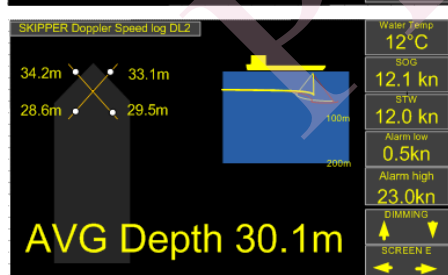

Screen E
Depth
(Option)

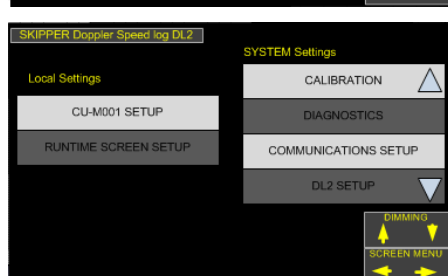

Screen Menu

On each display there are 5 configurable informations on the right as well as dimming buttons
 Pressing on the individual informations will allow the user to change the units or formats of the information. A long press on trip will reset the value.



DIMMING

Dimming is performed by touching the screen on the up down arrows. If the unit has been dimmed down so far that you cannot see the dimming button, then press and hold the screen for 5 seconds to return the screen to the mid-dimming point. It is also possible to remotely dim this screen using NMEA messages.

SCREEN SELECT

Screen select is performed by pressing sideway arrows.

Screen A Basic information

A simple screen showing resultant speed through water (STW) and speed over ground (SOG)

The default side menu shows:

- the measured water temperature, pressing will change the unit to fahrenheit
- The total distance travelled in water,
- the daily trip (pressing and holding will reset)
- The High speed alarm (for both SOG and STW)
- The low speed alarm (for both SOG and STW)

It is also possible to show a resultant current on this screen (dark green)



Screen B Combinations

A similar screen to screen A, this screen has 4 lines that can be adjusted to show 4 resultants (with rotating arrow) or velocities (with fixed arrows). Here the values can be selected from this system or other relevant systems such as GPS (green) or DL1(yellow on blue background (marked STW DL1))
 Screen C Docking screen

A screen designed to be used at low velocities to show the movement of the vessel.

This screen shows the longitudinal and transversal speed fore and aft, and the direction of current if available. Current may not always be present if thrusters are being used as these can disturb the STW values.



Screen C Rose diagram

A pictorial method of showing the available information on a compass rose if available (requires Heading NMEA input)

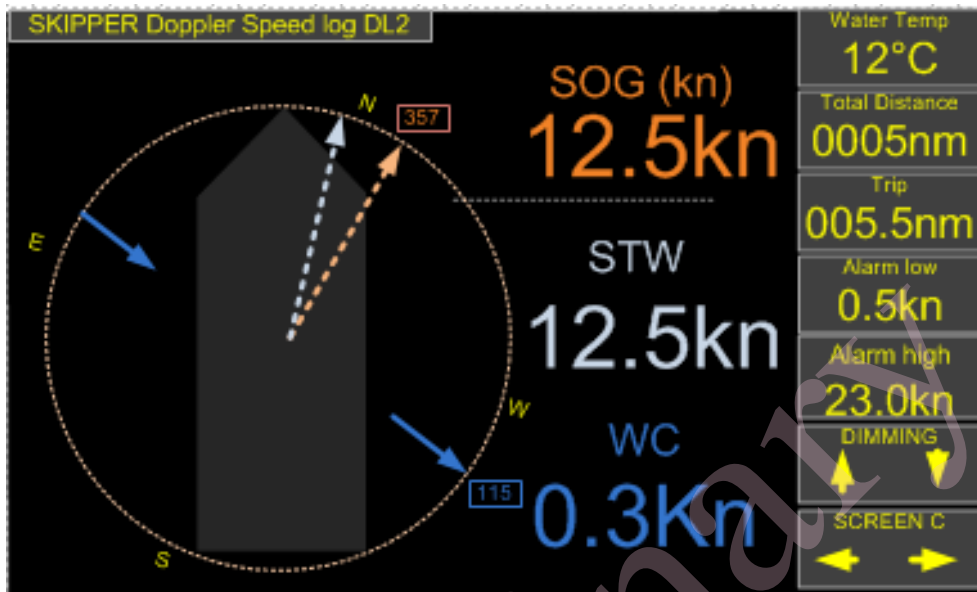

Screen E Depth information

As the DL2 system has acoustic beams tilted at 30 degrees from the vertical, the system can measure 4 depths. These are averaged to give a mean depth. This value is not as good as a normal echo-sounder, as the sound can bend as it passes through layers of water giving inaccuracies in the depth.

The diagram to the left shows the vessel and the approximate position of the measurement points with their values.

The diagram to the right is a traditional echogram, however it shows all the measured depths and the average in yellow.

THIS DEPTH INFORMATION IS NOT APPROVED AND CANNOT BE USED AS AN ECHOSOUNDER

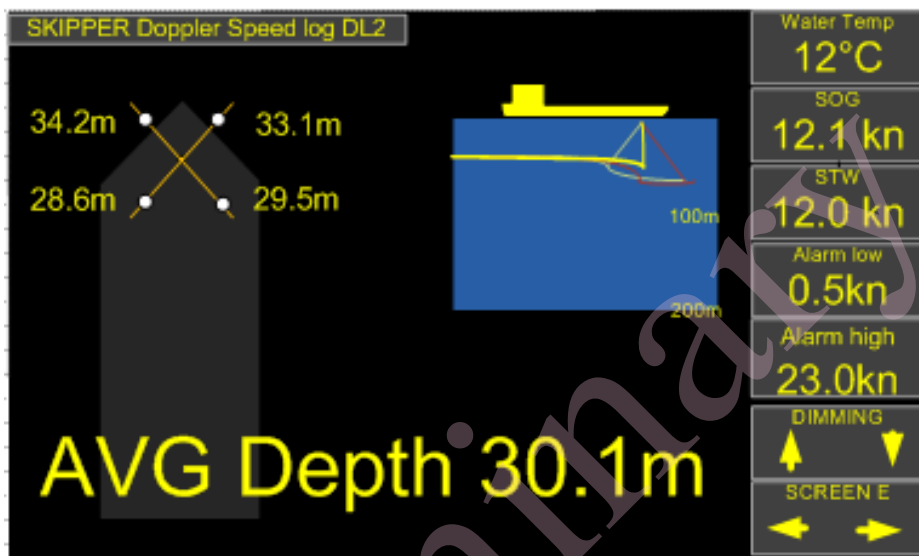

Screen MENU. Setup and Calibration

Local settings

CU-M001 setup. Setup communication with speed log etc

Runtime screen setup. Setup of screen A-E

System settings

Calibration. Calibration of speed and angular sensor offset.

Diagnostics. Self diagnostics of DL2 system.

Communication setup. NMEA In/Out, pulse out, AUX and alarm settings.

DL2 setup. Setting of vessel specific info.

Alarm. setting of alarm functions

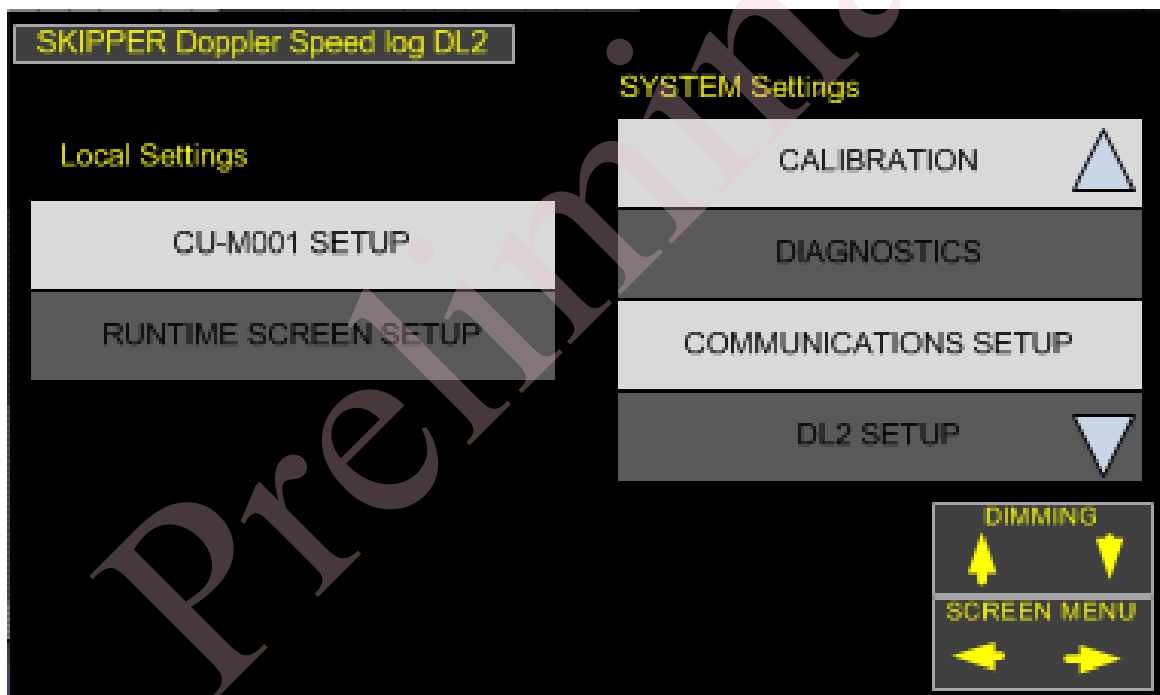

RUNTIME SCREEN SETUP

In this menu a runtime screen is selected on the left, and the available information is shown on the menus on the right. The first items are the main information, and the items information 1-5 allow the configuration of the information boxes on the right of the runtime screens.

SCREEN 1

Main Line 1: STW res

Main line 2: SOG res

Main line 3: Current

INFORMATION 1: W TEMP

INFORMATION 2: TOTAL

INFORMATION 3: TRIP

INFORMATION 4: ALR LO

INFORMATION 5: ALR HI

Available options:

- STW res, SOG res, Current res
- STW Long, SOG Long, OFF
- STW Tra, SOG Tra
- W Temp, TOTAL, STW2L, HDG
- Alarm Hi, TRIP, STW2T, ROT
- Alarm Lo, DEPTH, STW2, OFF

SCREEN C

STW Resultant: ON

SOG Resultant: ON

Current Resultant: To

Compass: ON

INFORMATION 1: W TEMP

INFORMATION 2: TOTAL

INFORMATION 3: TRIP

INFORMATION 4: ALR LO

INFORMATION 5: ALR HI

Available options:

- FROM, OFF
- W Temp, TOTAL, STW2L, HDG
- Alarm Hi, TRIP, STW2T, ROT
- Alarm Lo, DEPTH, STW2, OFF

Preliminary

CALIBRATION

Calibration is designed to adjust for differences of mounting and hydrodynamics (water flow around the vessel). The mounting will have a tilt, it will be offset in heading and the water drag of the ship may cause some variations. Mounting parameters are fixed, and speed changes due to drag are usually linear with speed. In most cases a single calibration is adequate, however on some vessels more may be required.

Speed logs are calibrated in the factory to give reasonable results after installation, however installation and hydrodynamics vary from vessel to vessel. It is therefore necessary to calibrate speed logs once in place.

SKIPPER speed logs have two parameters that need to be corrected by calibration.

1. Angular sensor installation error (heading error).
2. Speed variations due to drag or mounting tilt.

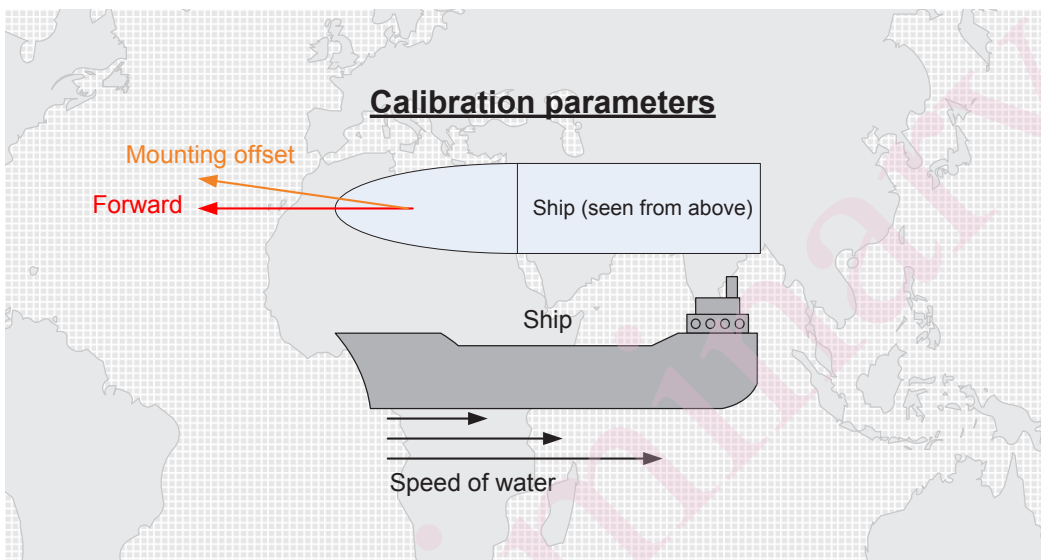

1. Heading Error

The heading error parameter corrects for an angular offset in mounting. This offset will result in a rotation of the measurement axes. The resultant speed will be unaffected, but the longitudinal and transversal components will be incorrect. An offset will result in the vessel typically showing too much transversal speed, but may also result in speed calibration failing (i.e. initial calibration fails when further points are added). This offset will show itself as an averaged drift on the calibration. **Reducing Heading errors.** New generation sea valves can be manually adjusted to ensure the sensor is correctly aligned. Alignment and heading offset are directly connected. To minimize the offset, the sensor should be mounted pointing ahead.

- **Tank mountings** have ahead marks on both the tank and the sensor insert.
- **Sea valves** have either a mark on the top flange or a flat mark on the port side of the pole which when a flat object is placed against this, will point fore/aft.

2. Speed variations due to drag or mounting tilt.

Every vessel will drag some water when it moves. This occurs over the whole hull. As you move further from the hull, the effect of the ships movement gets less. As the vessel moves at different speeds, the hydrodynamics of the vessel may change. In most cases the drag is even over the whole range of the vessel. Speed logs that measure on the surface of the vessel (such as EML) are more affected by this factor than sensors that measure remotely (Doppler). The calibration variation is usually less on remote sensors (sensors measuring away from the vessel).

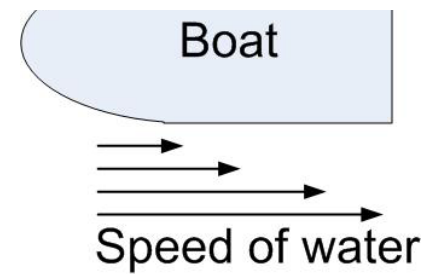

As the calibration factors can vary at different vessel speeds, it is possible to calibrate several speeds. It is typically necessary with only one high and one low speed. Speed logs with speed over ground can be compared with GPS speed over ground in stable conditions. However speed through water measures the influence of currents on the vessel, which cannot normally be measured on any other system. It is therefore important that full calibration is performed at least once for speed through water.

As previously explained, there are two factors to be calibrated, heading error and speed.

STEP 1. HEADING ERROR CORRECTION:

The vessel sails a steady course in calm waters and the user reads the resultant angle (averaged drift).

Speed over ground can be calibrated in two ways. (manual and semi-automatic). Speed through water can be approximated, but should be calibrated by sailing on opposite courses to get an accurate value.

STEP 2A. MANUAL SPEED CALIBRATION/ADJUSTMENT:

The user enters speed values directly into the calibration table by comparing to other equipment, such as GPS. This can also be used to adjust values.

STEP 2B. SEMI AUTOMATIC CALIBRATION:

The vessel is made to sail a known distance and course in both directions. This to remove any water current factors from the speeds. The 1st leg will show a different speed to the 2nd leg, however the direction changes in the second leg so that the average is correct.

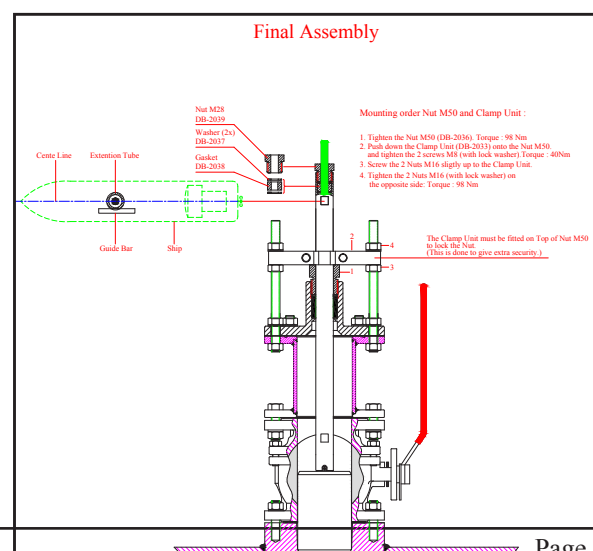

BACK

Avg Real Speed --kn
 Avg Meas speed STW --kn
 Avg Measured SOG --kn
 Avg Heading offset -- deg

Start Leg 1

Stop Leg 1

Enter leg distance

Stop Leg 1

Avg Real Speed --kn
 Avg Meas speed STW --kn
 Avg Measured SOG --kn
 Avg Heading offset -- deg

Start Leg 2

Result
 Avg Real Speed --kn
 Avg Meas speed STW --kn
 Avg Measured SOG --kn
 Avg Heading offset -- deg

Accept to calibration 1

Realtime:
 GPS Speed -- kn
 Measured SOG --kn Calibrated speed --Kn
 Measured STW --kn Calibrated STW --Kn

AUTO Calibration Status : POOR
 Long term difference of SOG-STW on calib 1 : -5%
 Long term difference of Heading on calib 1 : -3 degrees

Semi-Automatic

Calibration number	1
Real Speed	10.0kn
Measured STW	10.0kn
Measured SOG	10.0kn
Heading Offset	1.5 °

This calibration should take place during sea trial or if the sensor has been repaired or cleaned. Plot a line on the chart, that will take approximately 5 minutes to sail. Enter the distance of this line into the middle field, and then sail along the line (by track, not by heading) pressing the green start and stop at the beginning and end. If the REsulting factors look correct, click accept to transfer the data into the calibration number on the right. If you wish to perform a second calibration. move to the next calibration number and repeat.

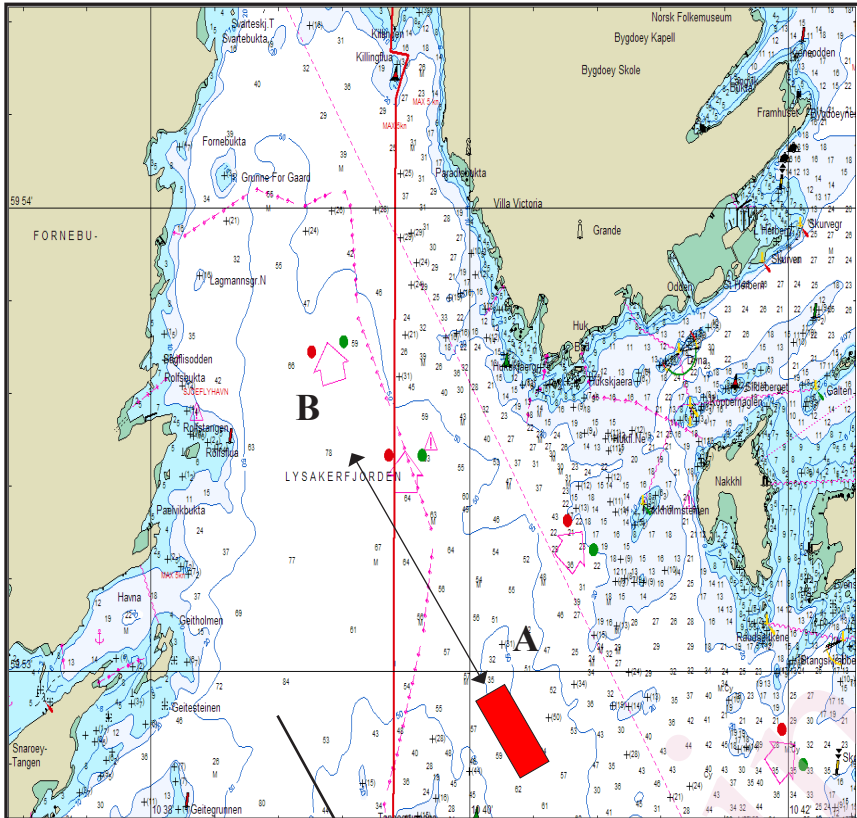

Figure shows plotting a calibration path on the chart.

The leg should take at least 5 minutes to sail (distance can be shorter when sailing slowly). Depth should be < 50 m to ensure that bottom track also calibrates correctly.

Note: These values may be overwritten in some software upgrades or if master reset is performed. We advise recording the values somewhere, just in case. Doppler systems typically have a calibration factor within 10 % i.e. measured 9 kn, real 10 kn.

CALIBRATION ROUTINE:

The calibration page is designed to help the user calibrate and check the calibration

The calibration data area at the top of the screen shows the current calibration settings and status for that calibration. These calibrations correct for drag of water or % errors in speed. This error can vary at different speeds of the vessel although this is unusual. However, we recommend two calibration points, one at high, one at low speed. Water track calibration can only be accurately corrected by sailing the vessel in 2 legs in opposite directions. The bottom track can be calculated by the same way or by comparing over time to the GPS. The graph to the right shows the current calibration curve (nominally a straight line), and the dots on the graph show the current speeds.

The calibration setup field allows the user to perform a calibration, monitor the results and accept them if these are correct. The user is guided through the process with green buttons showing the possibilities. If a value is to be manually corrected (if the vessel cannot be turned, for example), then the user should press the parameter and adjust. Alternatively a single leg can be sailed, and the value from that accepted into the selected setup number.

The heading parameters is the mounting offset of the sensor. With a correct mounting, it will be within ± 2 degrees. This value should be checked in various conditions and directions. A calibration run will show a value on screen, check this value in both directions, and if it is the same, accept it. The heading offset is calculated from the bottom track information.

The runtime status allows the user to check the performance of the system and calibrations. If GPS and gyro are connected, the system calculates the speed from these devices and checks against the measured values. It also checks stability of the signals using a long filter. These give a good indication of the speed stability while the vessel is not maneuvering. The integrity value is a summary of all the checks. If the integrity value is poor, the current situation is not good for performing a new calibration. This could be due to detected course changes, or speed fluctuations.

Once the calibration is complete, try sailing the vessel at various speeds and see if the GPS speed keeps to the BT calibration line in the graph. If it does not, then calibrate a new point near the point that is wrong. Note, the vessel should sail for at least 30 seconds before the value is checked as speed changes may cause temporary inaccuracies.

The system can be made to give more accurate readings using a combination of sensor, hardware and software algorithm options. However, accuracy is only as good as the calibration.

CUSTOM TRANSDUCER

If greater ranges or non standard form factors are required, custom transducer options are available. Changes in the form factor may influence accuracy and range. These options are based on known technology, but usually require a series of testing and, if required, extra approvals.

CALIBRATING THE SECONDARY SENSORS

The temperature and tilt sensors are mounted within the sensor. The temperature can have a slight offset due to the warmth generated by the nearby vibrating transducers. This can be calibrated on the calibration screen by entering the actual water temperature and the current measured temperature. The tilt sensors can be nulled using the null button on the calibration screen. If the vessel is listing, the user can add the actual list as an offset calibration.

DEPTH

Depth is calculated from the acoustic beams. Depth from each individual beam can be plotted on a depth plot and the average of all 4 can also be displayed. These depths are default from the sensor, and the draught setting must be used to make them display from the surface or from the hull bottom.

IMPROVING PERFORMANCE

With GPS connected, the system can detect if it has a long term difference in speed. In particular GPS SOG (Speed Over Ground) and SOG from the speed log should be the same. If there is a difference and this is stable over time, then adjustments can be made in calibration to compensate. If the system has 4 transducers or more, it contains redundancy for the required measurements. This means the system can get two independent measurements for the axes. These can be used for a self check. If these results do not show the same data, then the internal tilt sensor can be used to get yet another solution to find out which transducers are not performing satisfactorily. These functions are default in place, but can be removed if they are performing badly.

THINGS THAT MAY EFFECT PERFORMANCE:

The system sends acoustic beams into the water. These need reflections from the bottom for SOG and from particals in the water for STW. If the bottom is out of range then the bottom track will fail. If there are very few particals in the water, the signal may also be weakened.

If the vessel bow is breaching the surface, so that there is air in front of the sensor, then the system may temporarily loose the signal. Increasing the averaging will stabilise this data.

CHAPTER 3: NORMAL USEAGE

The system has two runtime screens used to show the measured information and/or relevant information from the connected systems regarding movement of the vessel. Elements on the screen can be selected, when available, and can be displayed graphically or numerically.

CHANGING SCREENS AND DIMMING

Screens can be changed by using the menu arrows on the lower right side of the screen. Pressing this will show the available screens, to get to the setup screens, press tconfig button on the top right. Each config screen is made up of a summary and some functions on the left, and parameters on the right. Clicking on these will give change to the next option, or present a keyboard or number pad to enter numbers directly

The Speed log measures both speed over ground (SOG) marked brown, and Speed through water (STW), marked blue. if the value is not available it will show -- (dashed line). SOG will be available only when the bottom is within range.

RUNTIME SCREEN 1



LOSS OF BOTTOM TRACK/OPEN OCEAN

If the bottom track is lost, normally due to depth outside of the range of the vessel, the system will put dashes into the areas with no data. If water current is selected and both GPS and heading are input, the current will use these data for compensation. If not, this parameter will not be available.

DISPLAY OF BOTTOM TRACK FROM GPS

If this function is enabled, the unit can be made to replace SOG information on screen with information derived from GPS and heading. This information is not given out from the units communication system, as it is not generated from this unit. (MED regulations)

SURFACE CURRENT MEASUREMENT

Surface current is measured in the water track cell. This cell size may vary in different water depth conditions, but it is shown on the depth display. Surface current has its own separate display allowing the user to adjust some of the parameters.

OTHER PARAMETERS

- **Temperature:** is measured at the water boundary, with in the sensor, its data is used internally to compensate for sound speed
- **Tilt,** is measured in the sensor, and is used internally for quality control of data
- **Depth,** is measured from all beams. These beams are slanted at approx. 30 degrees and will therefore not measure directly underneath the vessel. For this reason, they cannot be used as an approved sounder. However they can be output as a PSKPDPC NMEA message

SETTING THE ALARMS

Alarms can be set for high speed and low speed, If in use, they should be made accessible as informations on the right hand side. In this case they can be changed by pressing the information.

TRIP

The Trip values measures the distance travelled through water. The total is the distance since system installation, the trip can be reset to show daily trip or service intervals. If presented in an information the trip can be reset by pressing and holding the Trip information, otherwise the trip reset can be found in the DL setup menu. Trip can also be reset remotely as required in some standards from SKIPPER multirepeaters.

CHAPTER 4: WHEN SOMETHING IS WRONG

The DL2 is a Doppler speed log system with 4-6 PCBs (depending on option choices), a significant amount of cabling, an acoustic sensor and a hull mounting. All of these elements can fail, and SKIPPER has strived to make the system detect as many problems with these units as possible automatically. If the system does show signs of measuring wrongly, do the following:

- Check the calibration
- Check the self diagnostics

This (the self diagnostic) will test the following parameters:

- NMEA outputs
- Signal out of sensor
- Receiver sensitivity
- Internal voltages
- Temperature

If it finds an error, the diagnostic page will give you a suggestion of how to fix the unit. If the error is not found, Download and connect the SKIPPER service software (available on the SKIPPER website www.skipper.no). Select the DL2 symbol and perform diagnostics from there. If this gives no help, contact SKIPPER service or your local dealer. A full list of SKIPPER dealers is available on www.skipper.no.

The screenshot shows a diagnostic interface with the following elements:

- Graph:** A line graph with a yellow trace showing several peaks. A 'BACK' button is in the top left corner.
- Status Indicators:** Four buttons labeled 'Beam 1 Bottom', 'Beam 2 Bottom', 'Beam 3 Bottom', and 'Beam 4 Bottom'.
- System Status:**
 - Internal voltages: OK
 - Sensor connection: OK
 - Display connection: OK
 - Internal runtime checks: OK
- Diagnostic Messages:** A section labeled 'Diagnostic messages'.
- Control Panel:**
 - Diagnostic test: START
 - Simulate fixed speed: START (with a STOP button to its right)
 - Set fixed speed: 1Kn
 - Test Alarm output: START
 - Adjust beam length Bottom: 2ms
 - Adjust beam length Water: 8ms
 - Ping mode: Seperate (with a dropdown arrow)

This section shows two control elements:

- STW Ping length: Auto
- SOG Ping length: Auto

This page allows diagnostic testing, a speed simulation (forcing the sensor to simulate a speed. an alarm simulation and some parameters adjustments.

Preliminary

CHAPTER 5: SYSTEM DOCUMENTATION



Specifications Overview

	DL2	Units
Primary Frequency	500-600	kHz
Speed range (lon/tra)	+/-50	knots
Bottom lock	1-120+	meters
Water track (from)	3	meters
Aft transversal speed	opt.	
Pulse output power (rms)	30	Watts
Accuracy (better than)	0,2 or 2% whatever greater (1% option)	knots
Tilt accuracy	<2	degrees
Temperature accuracy	<1	°C
Mounting		
Seavalue:		
Single bottom	Yes	
Double bottom	Yes	
Steel tank	Yes	
Aluminium tank	Yes	
Speed alarms	High and low speed limits	
Clock	- Year-month-day/Hour-min-sec (taken from GPS if available)	
Outputs	- 4 x NMEA 0183 2 x LAN - 2 Digital Outputs (AUX) - 1 x contact closure - Alarm (Meets all current requirements for INS/ OSV)	
Inputs	LAN, NMEA02, Aux (user selectable)	
Optional ports	2x analogue Output(4-20mA or 0-10v) -extra x LAN -extra 1 NMEA 0183 input	
Optional Outputs	- extra 4 NMEA 0183	
Accepted NMEA formats		
Inputs		
Gyro	ROT, HDT	
GPS	GLL, GGA, RMC, VTG	
Echo	DPT, DBS, DBT, DBK	
Others	DPT, DBT, ACK, DDC	
Outputs		
Speed	VBW, VHW, VTG	
Distance	VLW	
Depth	DPT, DBS, DBT, DBK	
Others	MTW (temp), ALR / ALF (alarm) PSKPDPC (4 slanted depths)	
Power Supply	AC 115 - 230 V 50/60 Hz, DC, 24 V	
Power Consumption	Max. 60 W	
Display	9.0" Panel PC with LAN connection	
Memory	SD Flash - For retaining operational settings and diagnostic data	
Languages	English	

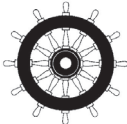
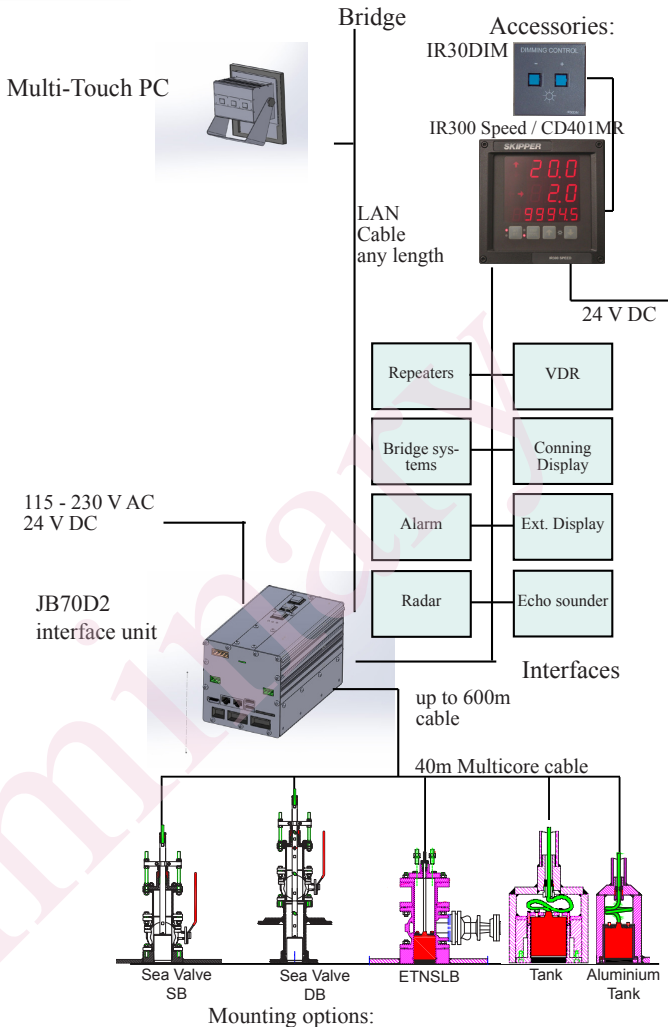

SKIPPER Electronics AS
 Enebakkveien 150
 P. O. Box 151, Manglerud
 0612 Oslo, Norway
 E-mail: sales@skipper.no
 Telephone: +47 23 30 22 70
 Telefax: +47 23 30 22 71
 Co. reg. no: NO-965378847 -MVA
 www.skipper.no
 Date: November 2013
 Revision: 25112013

Note*: Some specification points can be improved using the available options.

Preliminary

SKIPPER

SKIPPER Electronics AS
Enebakkveien 150
P. O. Box 151, Manglerud
0612 Oslo, Norway
www.skipper.no

Telephone: +47 23 30 22 70
Telefax: +47 23 30 22 71
E-mail: support@skipper.no
Co. reg. no: NO-965378847-MVA